

# Salem B 40 (300x300)

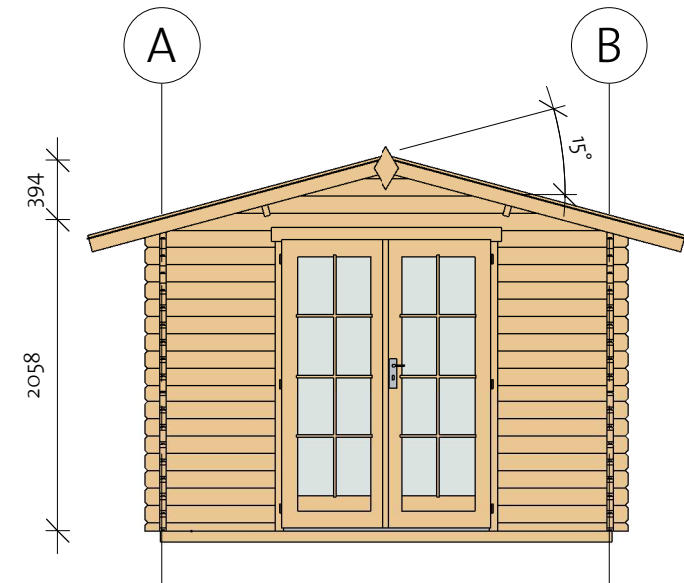

# Salem B 40 (300x300)

Foundation

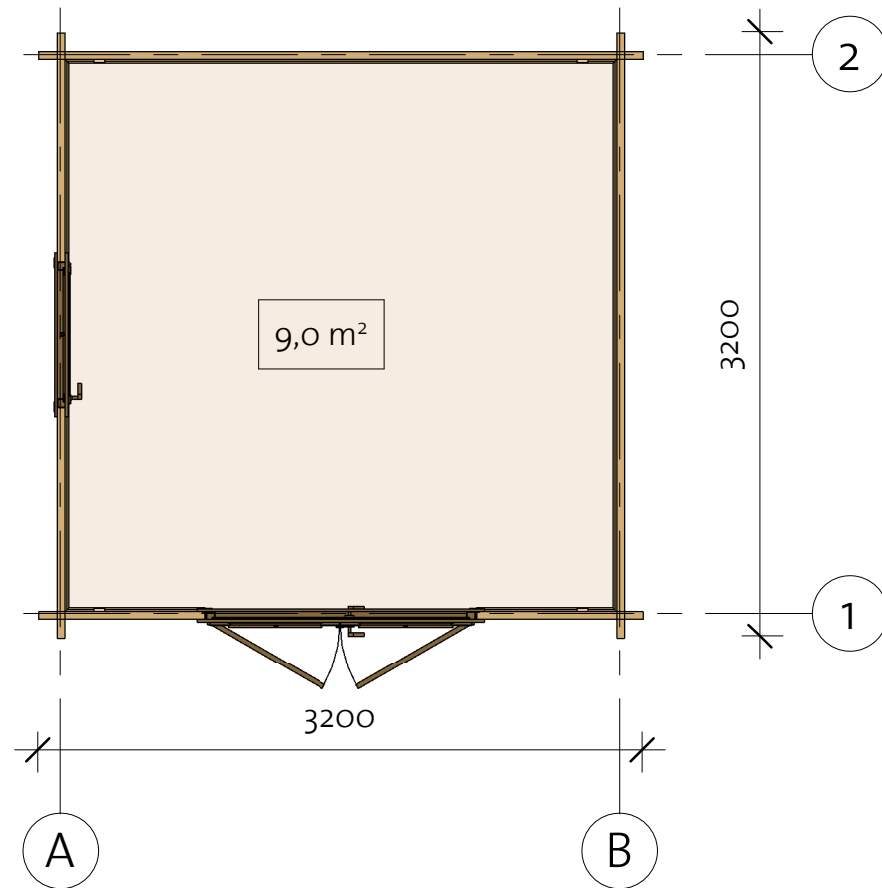
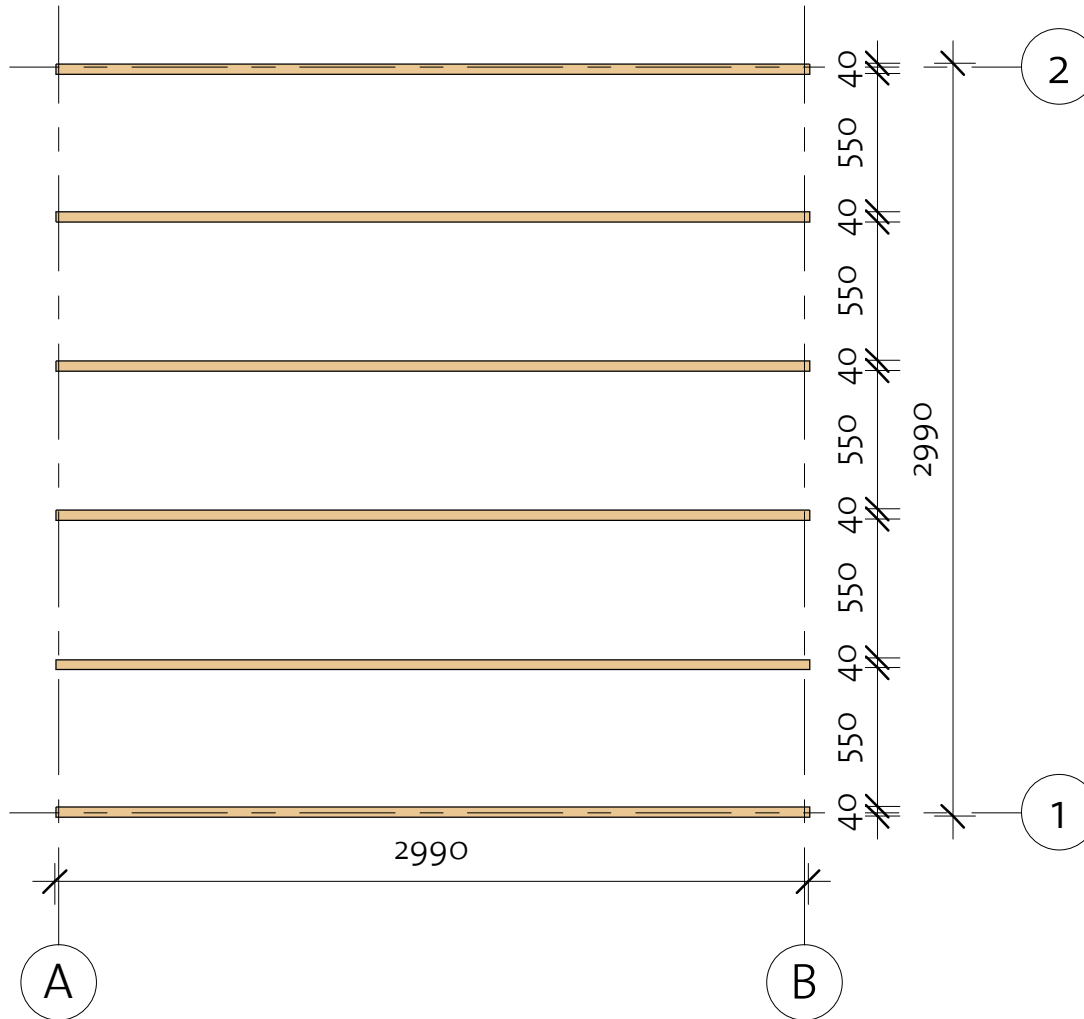

Impregnated foundation beams				
Mark	Type	Profile	Count	Length

IFB	IFB 40x70		6	2990
-----	--------------	---	---	------

# Salem B 40 (300x300)

Floor Plan

① Baseboard

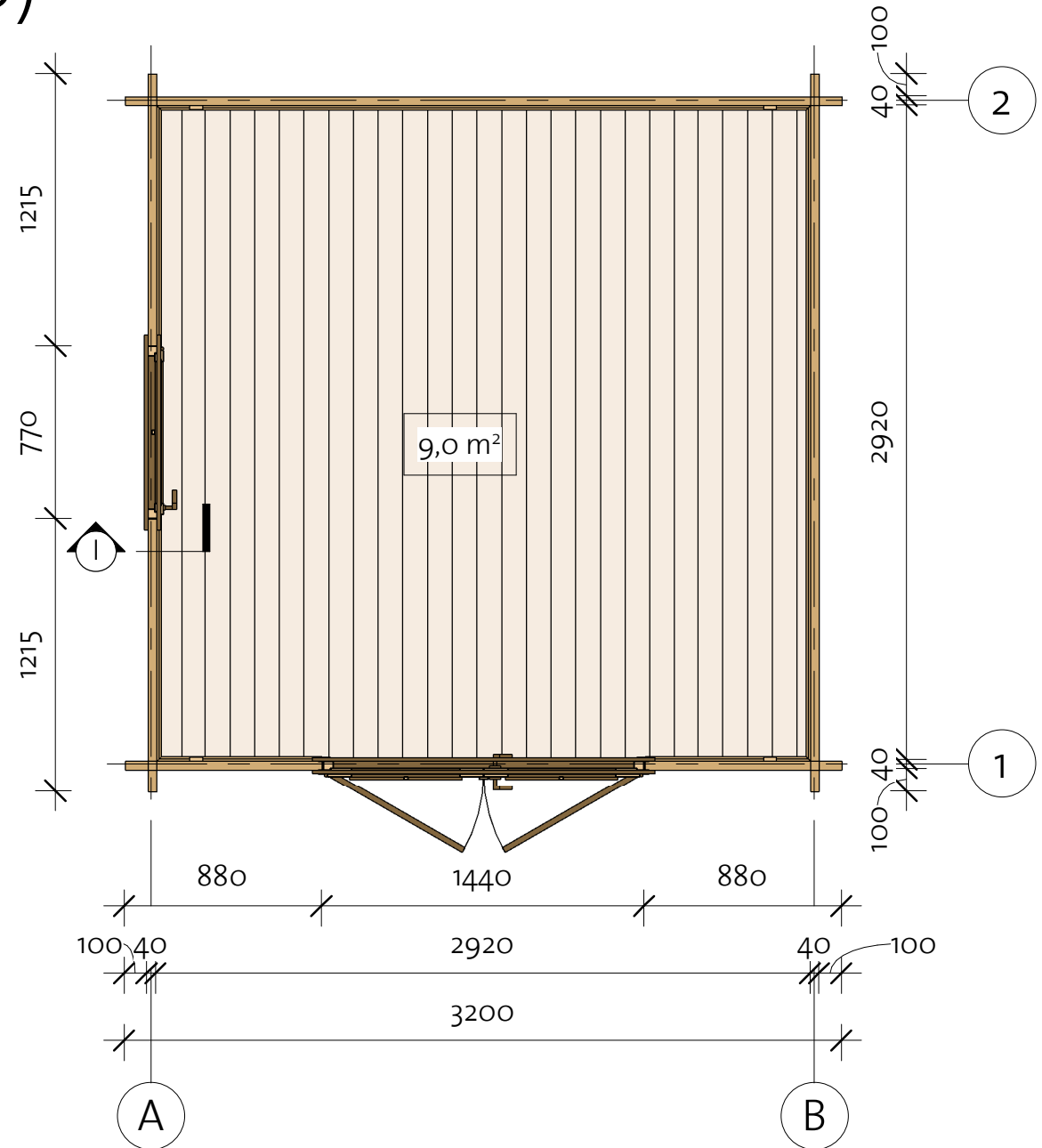
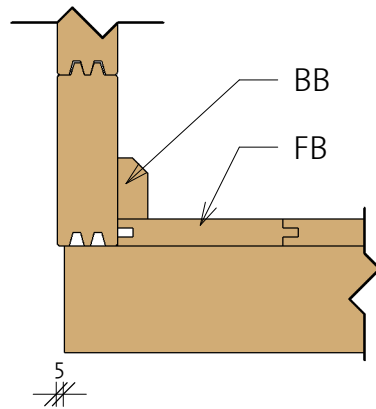

Floor Schedule

Mark	Type	Profile	Count	Length
FB	FB 17x114		27	2914
BB	BB 20x40		4	3000

# Salem B 40 (300x300)

Wall 1

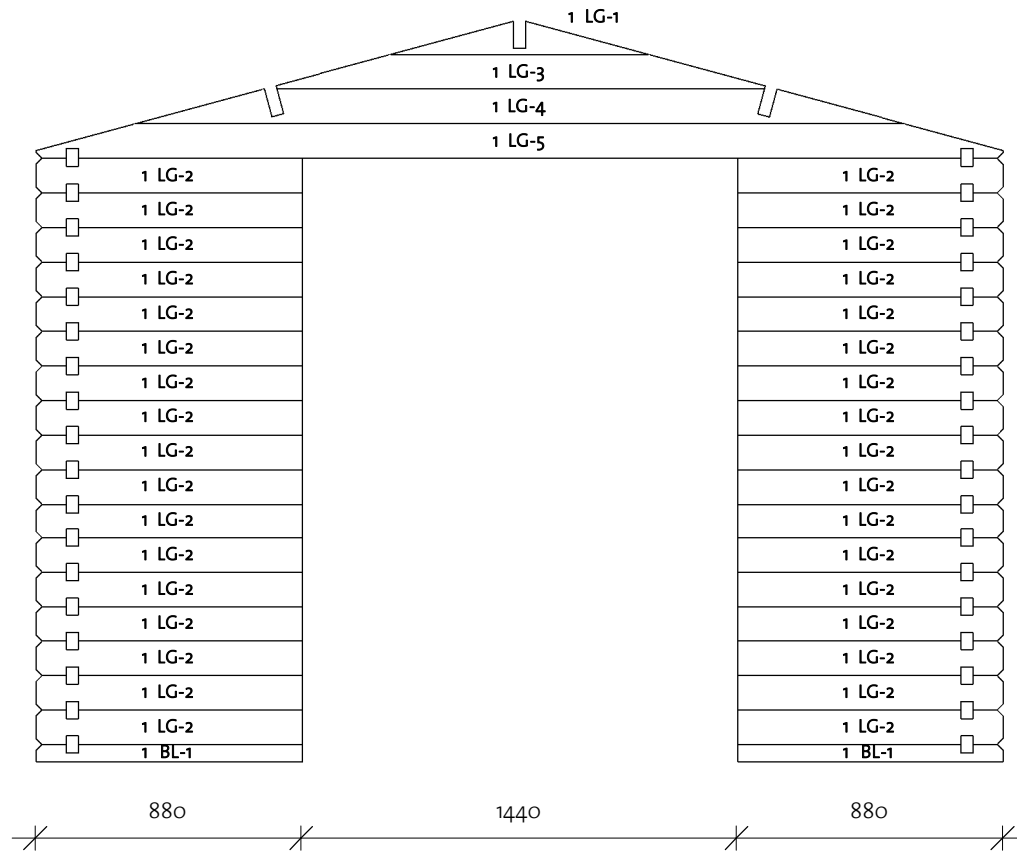
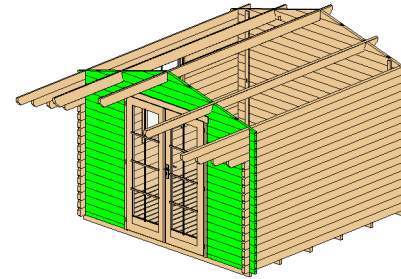

Wall 1			
Mark	Profile	Count	Cut length

1BL-1	40x57	2	880
1LG-1*	40x114	1	837
1LG-2	40x114	34	880
1LG-3*	40x114	1	1597
1LG-4*	40x114	1	2503
1LG-5*	40x114	1	3198

\* Gable - delivered premounted

Log Profile Wall 1	
Profile	Profile

40x57	
40x114	

# Salem B 40 (300x300)

Wall 2

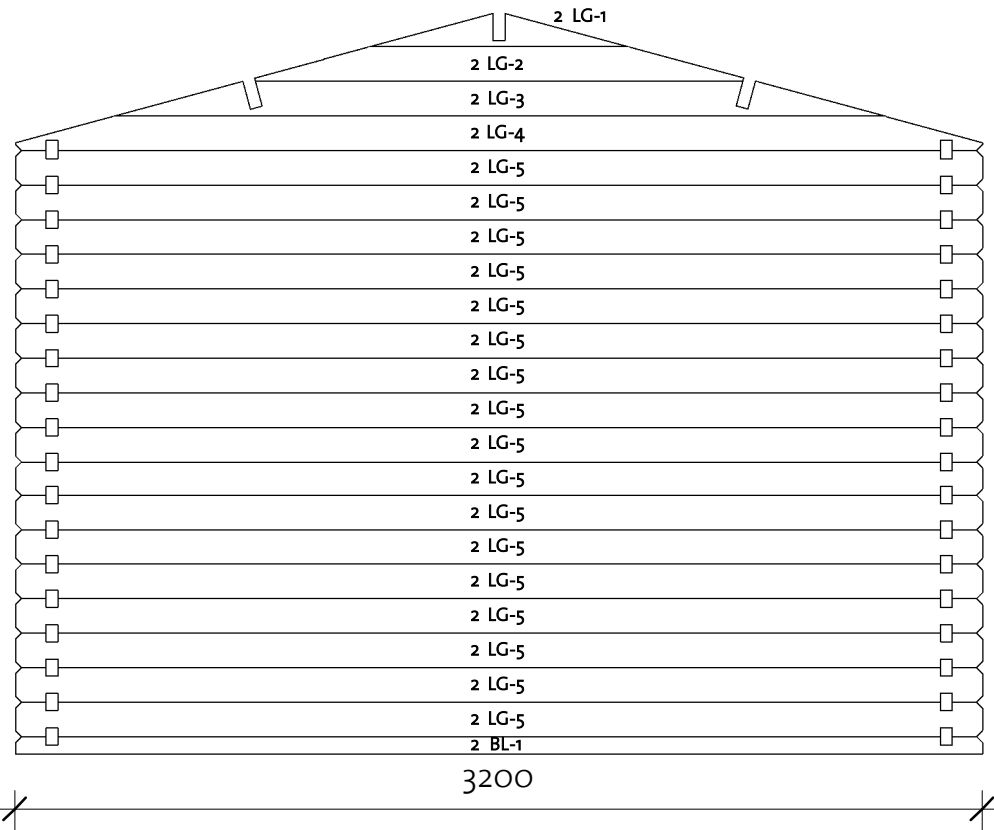
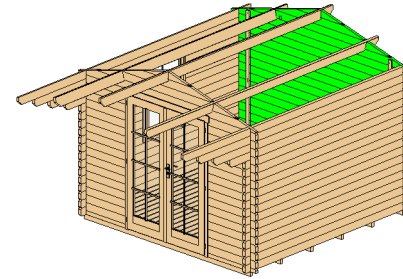

Wall 2			
Mark	Profile	Count	Cut Length

2BL-1	40X57	1	3200
2LG-1*	40X114	1	837
2LG-2*	40X114	1	1597
2LG-3*	40X114	1	2503
2LG-4*	40X114	1	3198
2LG-5	40X114	17	3200

\* Gable - delivered premounted

Log Profile Wall 2	
Profile	Profile

40X57	
40X114	

# Salem B 40 (300x300)

Wall A

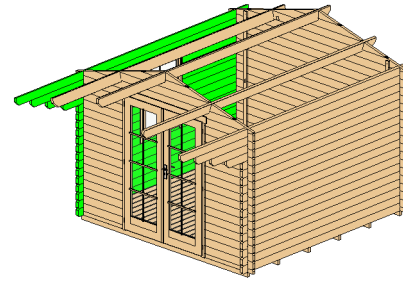

Wall A			
Mark	Profile	Count	Cut Length

ALG-1	40X114	16	1215
ALG-2	40X114	1	1515
ALG-3	40X114	1	1815
ALG-4	40X114	7	3200
ALG-5	40X114	1	4100
ATL-1	40X114	1	4500

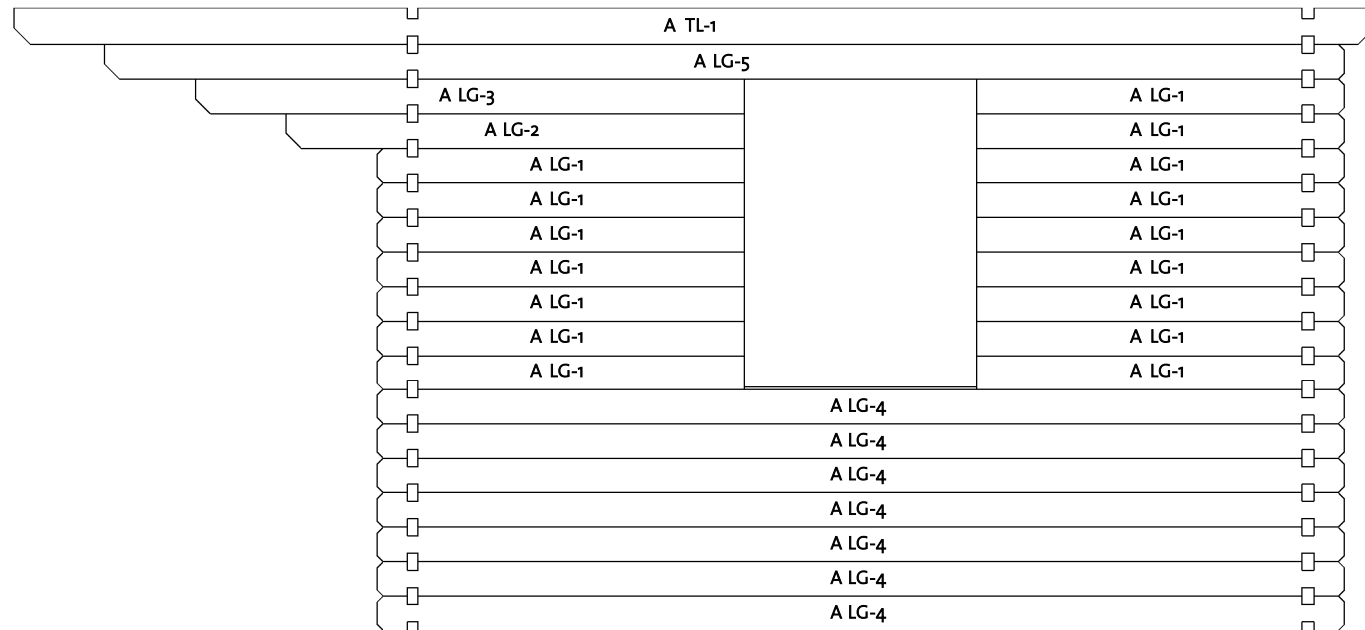

Log Profile Wall A	
Profile	Profile

40X114	
40X114	

# Salem B 40 (300x300)

Wall B

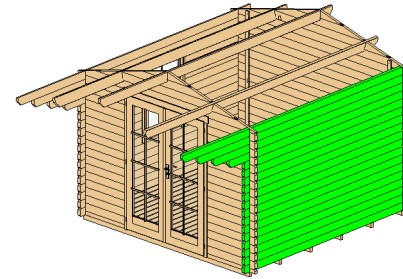

Wall B			
Mark	Profile	Count	Cut Length

BLG-1	40X114	14	3200
BLG-2	40X114	1	3500
BLG-3	40X114	1	3800
BLG-4	40X114	1	4100
BTL-1	40X114	1	4500

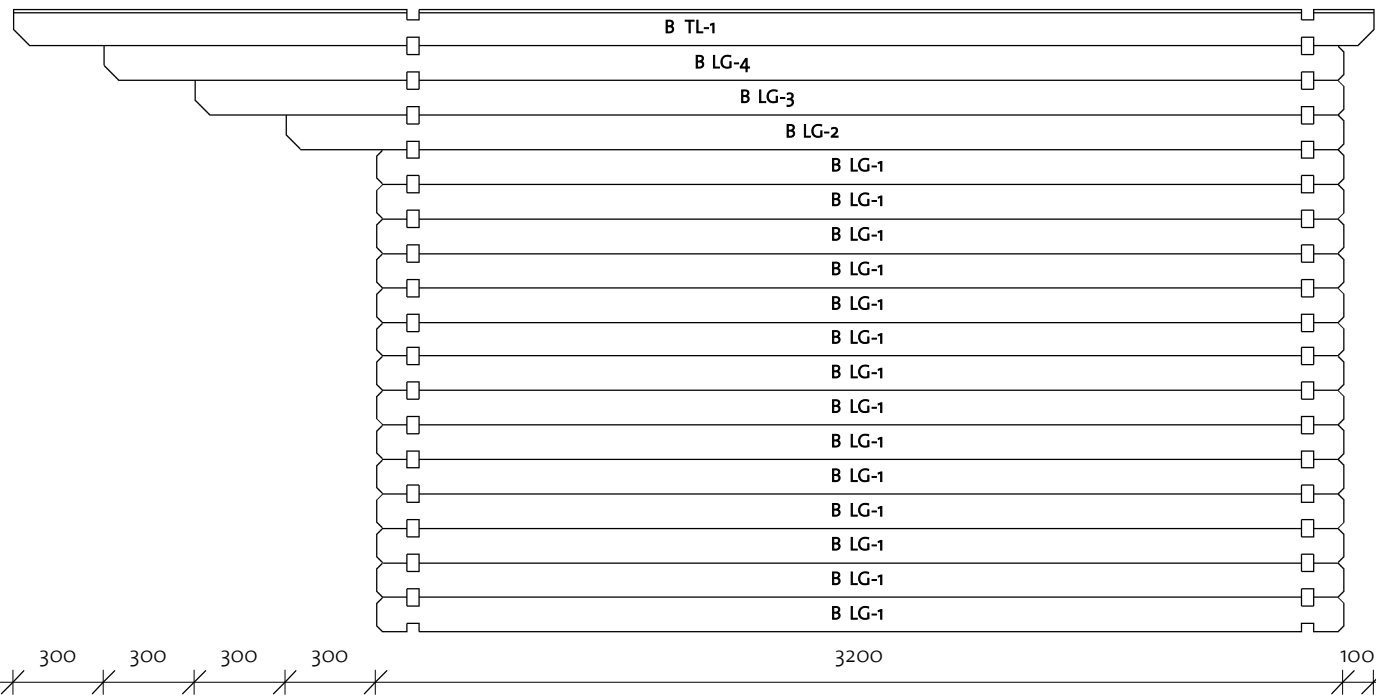





Log Profile Wall B	
Profile	Profile

40X114	
40X114	

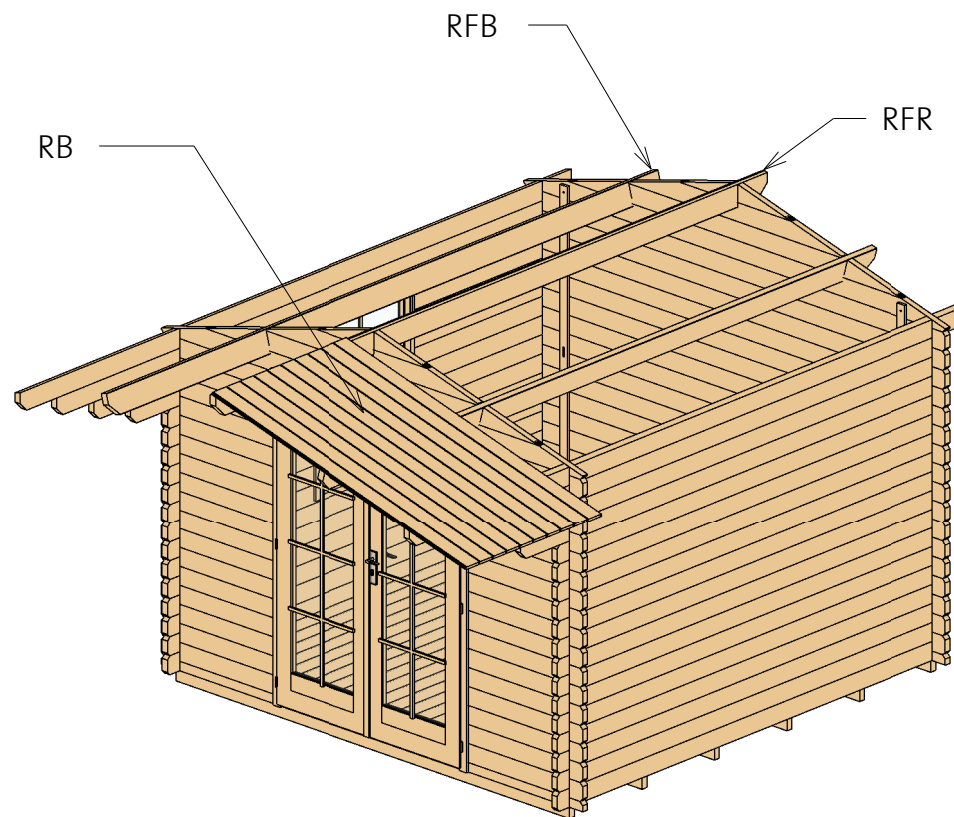
# Salem B 40 (300x300)

Roof 1



Roof				
Mark	Type	Profile	Count	Length
RFR	Ridge 40X143		1	4500
RFB	Beam 40X143		2	4500
RB	17X114		82	1976



# Salem B 40 (300x300)

Roof 2

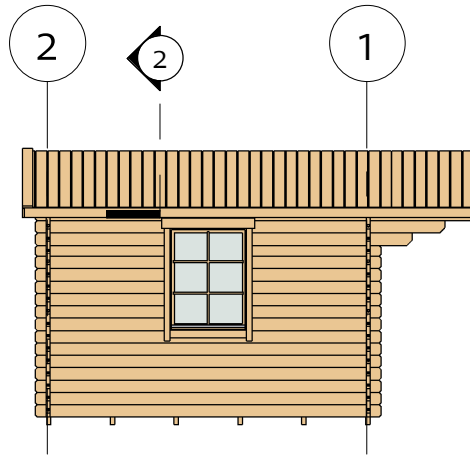

② Facia

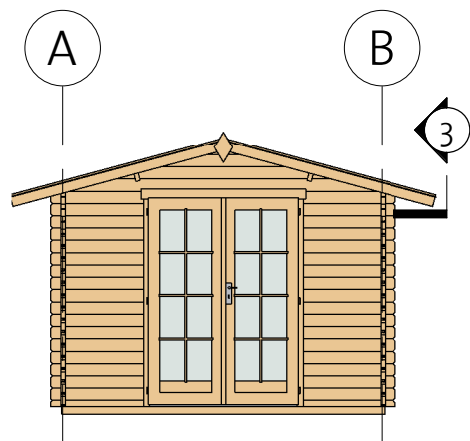
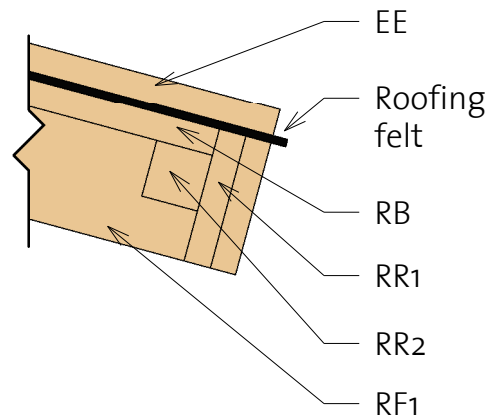

③ Roof Reinforcement

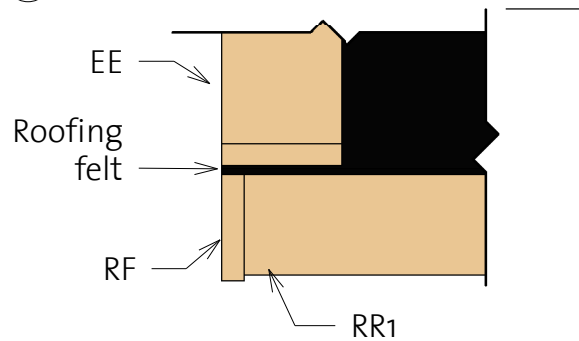

Fascia Schedule				
Mark	Type	Profile	Count	Length
EE	Eave Edging 18x95		4	2015
RF	Roof Fascia 18x95		4	2015
RR1	Roof reinforcement 18x95		2	4500
RR2	Roof reinforcement 38x38		2	4500

# Salem B 40 (300x300)

Extras

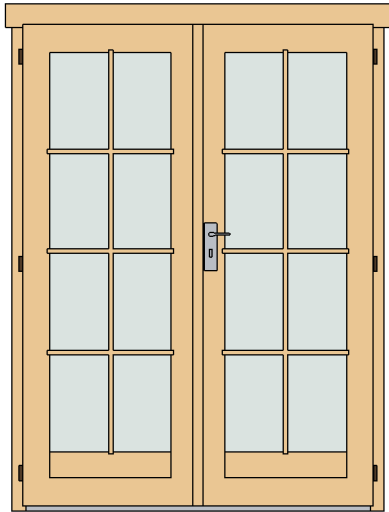

Door Schedule				
Mark	Type	Width	Height	Count
CDD3R	Classic double door 3 right	1425	1955	1
DCB8	Door Crossbar 8	--	--	2

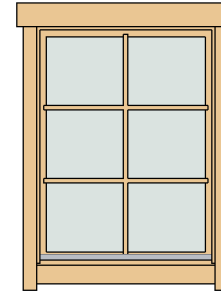

Window Schedule				
Mark	Type	Height	Width	Count
CW1R	Classic window 1 right	990	765	1
WCB6	Windows Crossbar 6	--	--	1

Fasteners & Extras		
Name	Type	Count
Hitblock	300-400 mm	
Screws	5,0 x 70	10
Bolts	M8 x 70	12
Screws	6,0 x 140	25
Nails	1,4 x 40	30
Screws	4,0 x 40	540

Type	Count	Length
Windboard 18x40	4	2000



Type	Count
Romb	2

# Salem B 40 (300x300)

## List of all items 1



### Impregnated foundation beams

Mark	Type	Profile	Count	Length
IFB	IFB 40x70		6	2990





### Floor Schedule

Mark	Type	Profile	Count	Length
FB	FB 17x114		27	2914
BB	BB 20x40		4	3000

### Roof

Mark	Type	Profile	Count	Length
RFR	Ridge 40x143		1	4500
RFB	Beam 40x143		2	4500
RB	17x114		82	1976

### Fascia Schedule

Mark	Type	Profile	Count	Length
EE	Eave Edging 18x95		4	2015
RF	Roof Fascia 18x95		4	2015
RR1	Roof reinforcement 18x95		2	4500
RR2	Roof reinforcement 38x38		2	4500

# Salem B 40 (300x300)

## List of all items 2

Wall 1			
Mark	Profile	Count	Cut length

1BL-1	40x57	2	880
1LG-1*	40x114	1	837
1LG-2	40x114	34	880
1LG-3*	40x114	1	1597
1LG-4*	40x114	1	2503
1LG-5*	40x114	1	3198

Wall 2			
Mark	Profile	Count	Cut Length

2BL-1	40x57	1	3200
2LG-1*	40x114	1	837
2LG-2*	40x114	1	1597
2LG-3*	40x114	1	2503
2LG-4*	40x114	1	3198
2LG-5	40x114	17	3200

\* Gable - delivered premounted

Wall A			
Mark	Profile	Count	Cut Length

ALG-1	40x114	16	1215
ALG-2	40x114	1	1515
ALG-3	40x114	1	1815
ALG-4	40x114	7	3200
ALG-5	40x114	1	4100
ATL-1	40x114	1	4500

Wall B			
Mark	Profile	Count	Cut Length

BLG-1	40x114	14	3200
BLG-2	40x114	1	3500
BLG-3	40x114	1	3800
BLG-4	40x114	1	4100
BTL-1	40x114	1	4500

Log Profiles	
Profile	Profile

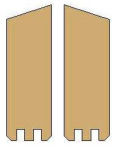
40x57	
40x114	

Log Profiles	
Profile	Profile

40x114	
--------	--